Electrical Automation of Solar Cell-Based Arduino Uno With 16 × 2 LCD Display

Electrical
Automation of
Solar Cell

629

Mohammad Irfan Fahmi and Hidayatullah

*Akademi Manajemen Informatika dan Komputer Royal, Sumatera Utara,
Indonesia*

Jhonson Efendi Hutagalung

*Akademi Manajemen Informatika dan Komputer Royal, Sumatera Utara,
Indonesia*

Sajadin Sembiring

Universitas Sumatera Utara, Medan, Indonesia

Abstract

Research to find new energy source is still an intensive work by researchers in this field. One of the energy sources with no negative impact to environment is solar energy. Solar cell is used to convert solar energy to electrical energy. The electrically powered solar cell in direct current (DC) power is not suitable for our daily office equipment since they need the alternating current (AC) power. This research has succeeded in realizing a solar cell automation tool based on Arduino Uno with input from solar energy, from which output AC voltage can be used for the needs of household appliances and office equipments. Output power of this tool is approximately 700 W, which can turn on the lights, charge the hand phones, laptops, and so forth.

Keywords Solar cell, Arduino Uno, LCD 16 3 2, electrical automation, inverter, AC power

All papers within this proceedings volume have been peer reviewed by the scientific committee of the Malikussaleh International Conference on Multidisciplinary Studies (MICoMS 2017).

Introduction

Energy requirements are increasingly rising with the rate of growth of development in Indonesia. This is the same with the needs of electrical energy. Almost every field of development requires electrical energy in the process of its activities. This is understandable

This work is supported in part by a grant from the Royal Education Foundation of Asahan and the University of Sumatera Utara.

The authors thank Prof. Dr. Herman Mawengkang from the University of Sumatra for his advice in writing this work. They also thank the fellow researchers in the Royal Computer Informatics Management Academy.

© Mohammad Irfan Fahmi, Hidayatullah, Jhonson Efendi Hutagalung, Sajadin Sembiring. Published in the Emerald Reach Proceedings Series. Published by Emerald Publishing Limited. This article is published under the Creative Commons Attribution (CC BY 4.0) licence. Anyone may reproduce, distribute, translate and create derivative works of this article (for both commercial and non-commercial purposes), subject to full attribution to the original publication and authors. The full terms of this licence may be seen at <http://creativecommons.org/licenses/by/4.0/legalcode>



Emerald Reach Proceedings Series
Vol. 1
pp. 629-639
Emerald Publishing Limited
2516-2853
DOI 10.1108/978-1-78756-793-1-00099

because the growth of development in our country is marked by the growth rate of the industry, both the medium and large industries, and all of them require electrical energy for lighting and to move the machines.

The search for new energy sources should meet the requirement that is generating a large amount of energy, economic costs, and no negative impact on the environment. One of the qualified energy sources is solar energy. By using solar cell, solar energy can be converted into electrical energy, both in the business world and the industrial world, and thus increase the electrical energy sources.

Solar cell (Photovoltaic cell) technology serves to convert solar radiation into electrical energy directly. Photovoltaic cell is usually packaged in a unit called a module. A solar module consists of many solar cells that are biased in a series or parallel arrangement. The solar cell became popular recently with the depletion of fossil energy reserves and global warming issues. Energy is also very cheap because the source of solar energy is very abundant and is biased to get for free (Rosidi, 2016).

In addition to industrial sectors, there are also still many other sectors that really need electric energy. One is for household purposes. Thus it is clear that the use of electrical energy is increasingly increasing. The need of 220 V alternating current (AC) power source is very important, for example, for the purposes of household appliances such as television, refrigerator, lighting, sterika, and so forth. Although it requires a high enough cost for solar cell. Solar power equipment (solar cell) is suitable for areas that are short of electricity or often power outages or for areas having absolutely no electricity.

The power generated by a single solar cell is so small that it takes some solar cells that are combined into a component that is called solar panel or solar module. Solar cell is the main equipment of solar power system that serves to convert mathar light energy into electrical energy directly. The output power generated from the conversion process is determined by some environmental conditions in which a solar panel is like the intensity of sunlight, temperature, the direction of sunlight, and the spectrum of sunlight.

The maximum power generated under these standard conditions is used as the output power of a solar panel and the selling price of the solar panel is determined by this power value. Unfortunately the standard test conditions are very difficult to find in real operating conditions (Fachri MR, 2015).

Literature review

Arduino is an electronic kit or open source electronic circuit board in which there is a main component, a microcontroller chip with AVR type from Atmel company. The microcontroller itself is a chip or IC (Integrated Circuit) programmed using a computer.

In general, Arduino consists of two parts, namely:

- (1) Hardware in the form of input/output board (I/O) is an open source.
- (2) Arduino software which is also open source, including Arduino IDE software to write programs and drivers for connection with computer

The usefulness of the Arduino depends on us making the program. Arduino can be used to control the LED, control the traffic lights, and can also be used for robot design.

Currently there are various forms and types of Arduino boards that are adjusted to the designation, not only board (board) Arduino there is also another module ready to use (shield), as well as accessories such as USB adapter and so on.

Many programming languages are commonly used for microcontroller programs, such as assembly language. But Arduino programing language used the language C. Language C

is a language that is very commonly used since the beginning of the computer was created and very instrumental in software development.

Arduino Integrated Development Environment (IDE) is a software provided at arduino.cc site designated as a sketch development tool and used as an Arduino ideas program (IDE), which means an integrated program development tool where various needs are provided and expressed in the form of menu-based interface. By using Arduino ideas, we can write a sketch, check for errors or not on sketch, and then upload a compiled sketch to an Arduino board (Abdul khadir, 2014).

Sensor and design module

Solar cells are thin layers made of pure silicon semiconductor (Si) and other semiconductor materials. Electric power generated by a single solar cell is so small that it takes some solar cells that are combined into a component called solar panels or solar modules.

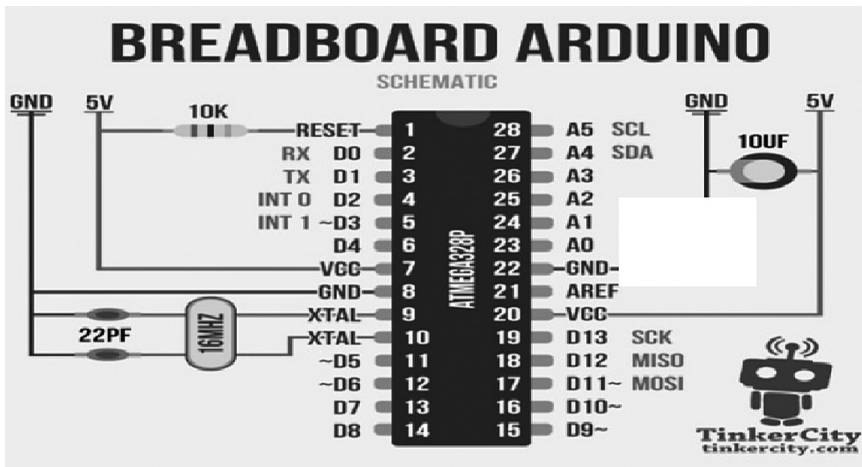

Figure 1.
Breadboard Arduino
(Syahwil, 2013, p. 24)

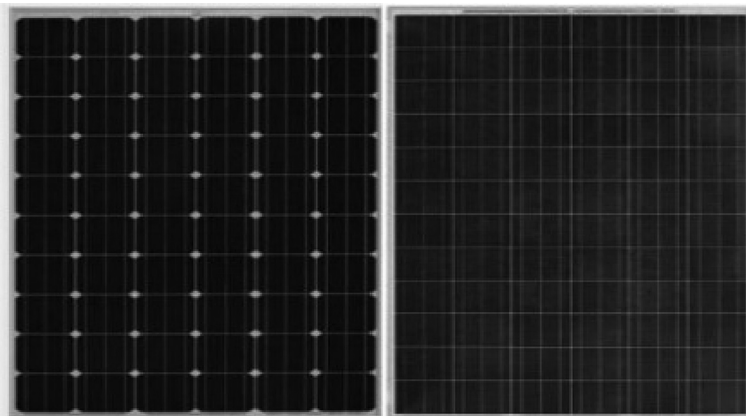

Figure 2.
Solar Panel Type –
Monocrystalline and
Polycrystalline

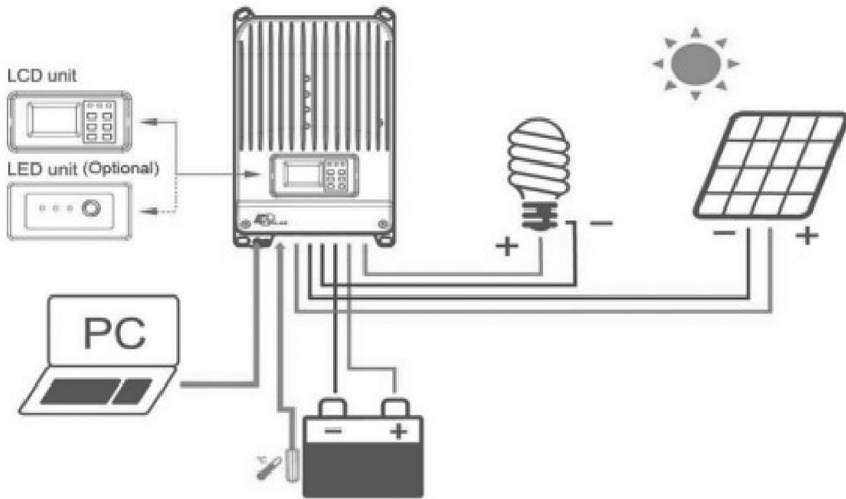

Figure 3.
Solar Charge
Controller Structure

The solar charger controller can also be referred to as a battery regulator that serves as a device that regulates the charger process that is sourced from the electric current generated from the PV module to the battery and to adjust the discharger process to a load connected to a solar charger with a voltage of 12 V and a maximum current rating of 10 A.

Solar panel can actually be used directly without a solar charger or battery charger circuit, but this is not done because it can overload the performance of the panel due to excessive load and hence there will be fatal damage to the solar panel. In addition to this solar charger controller also secures the solar panels from the overload so that they are not

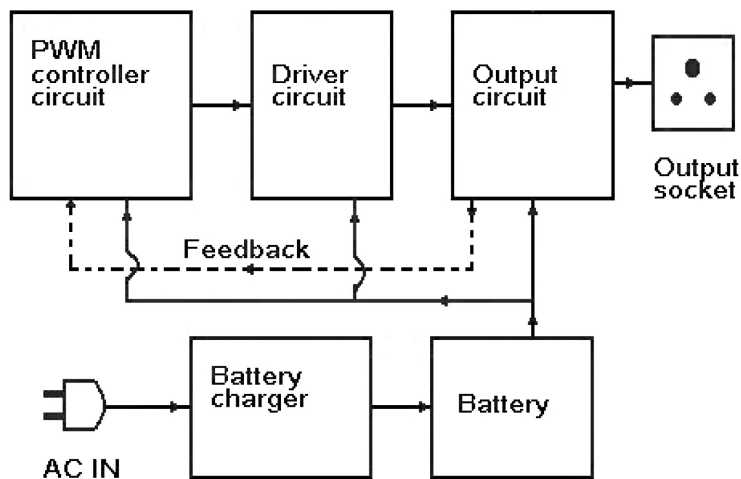

Figure 4.
Pulse Width
Modulation Inverter

easily damaged. If we want the output of electricity from this PLTS in the form of electric AC then the already discharged the direct current (DC) power must be connected to an electronic circuit/electronic module named Inverter DC-AC (Irawadi, 2016).

The inverter is used to change the DC voltage from the accumulator to AC voltage in the form of a sine signal after going through the formation of wave and filter circuit. The resulting output voltage must be stable, both the amplitude and the frequency of the resulting voltage, the distortion should be low, there should be no transient voltage, and cannot be interrupted by a state.

Generally high voltage generator consists of high-voltage back and forth (AC), high-voltage generator direction (DC), and high impulse voltage generator. High voltage back and forth is required, among others for dielectric testing, corona testing, dielectric strength testing, and resistance testing.

The high-voltage back and forth voltage is obtained from a one-phase transformer commonly referred to as a test transformer with a turning ratio much larger than that of a power transformer (Syahbi, 2012).

The series of high-voltage generating back and forth is shown in Figure 5.

Miniature Circuit Breaker (MCB) (figure 2) is a circuit safeguard equipped with a thermal protection (bimetal) for overload protection and also equipped with electromagnetic relays for short circuit protection. MCB is widely used for single phase and triple phase circuit. Miniature Circuit Breakers (MCB) are designed with the main function to secure the cable against the overload (Pefrianus Bung, 2015).

Batteries are one component of energy storage that can convert electrical energy into chemical energy and chemical energy into electrical energy. Many types of batteries can be used in this system. One is the lead acid battery.

This battery is made up of several electrochemical cells and each cell operates by using a positive electrode (anode) made of PbO_2 (lead oxide) and negative electrode (cathode) of Pb (lead), while the electrolyte solution used consisted of sulfuric acid (H_2SO_4) and water (H_2O). For a nominal 12 V battery it usually consists of six cells with each cell having a voltage of 2 V.

Research methodology

To assist in the preparation of this research, there is a need for a clear framework of work (Frame Work). This framework is a step that will be done in the discussion of the design of automatic electrical prototype. Hardware analysis will be done, each sub-module of the device used to know the basic working system only will be tested, and the circuit path of each module will also be discussed, so that when combined can form Arduino Uno Solar Cell Automation System With 16×2 LCD Display.

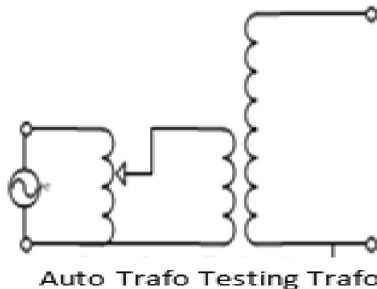

Figure 5.
High-Voltage
Generating Circuit
Back and Forth



Figure 6.
Miniature Circuit
Breaker

The Arduino R3 test is intended for proof, whether the command written in the Arduino R3 runs in accordance with the desired command. Arduino R3 test to be tested is done in two ways, that is testing by using Digital PIN and Analog PIN.

Figure 7 describes the value received from Analog PIN from LDR. When the LDR is given a light, the value will be enlarged and when the LDR is not lighted, the value on the monitor series will decrease.

The design of the tool created is an overview of the tool whose working principle is used. From the results of the use of power generated from inverter of 10 W, AT8535 microcontroller, battery adapter, 16×2 LCD, and the circuit used inverter to supply 12 V DC battery turn on the switch directly.

In the inverter there is also a 5 V DC voltage which aims to power AT8535 and LCD Microcontrollers, the output generated in the design of this tool 10 W on the inverter that can re-charge the battery by using the battery adapter.

Hardware design (Hardware) is designed according to the diagram shown in Figure 8.

In this case, context diagram serves as a medium consisting of a process and some external entity. The context diagram in question can be seen in Figure 9.

Results and discussion

LCD 1602 + I2C is tested to display information. So the movement information will be read on the Analog pin, and will be displayed. The use of I2C is enabled to reduce the use of Arduino R3 digital pins.

Testing solar cells is a test run on solar panels in which the input voltage source is the sunlight (DC voltage) and voltage storage is controlled using batteries and MCB after input

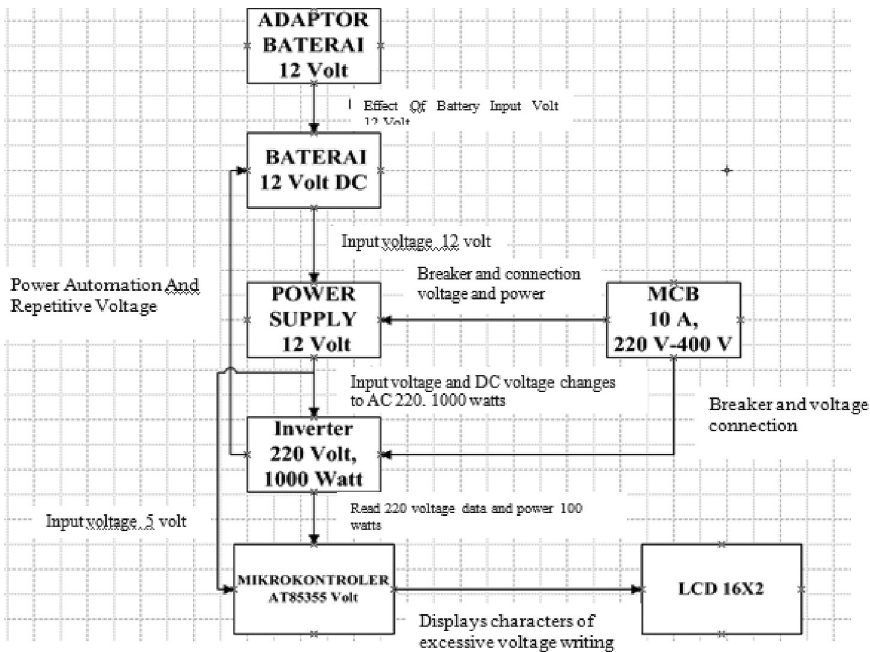

Figure 7.
Hardware Design
Inverter Tools

voltage is processed. Then DC voltage is converted into AC with the help of an inverter at a voltage of 12 V. Finally the output (output) is in the form of glowing lamp.

Hardware module we use is the of LCD 1602 + I2C, flow sensor, MCB, Inverter, and Arduino R3 controller. All these modules are merged into an Arduino Uno-Based Automation System with 16×2 LCD display.

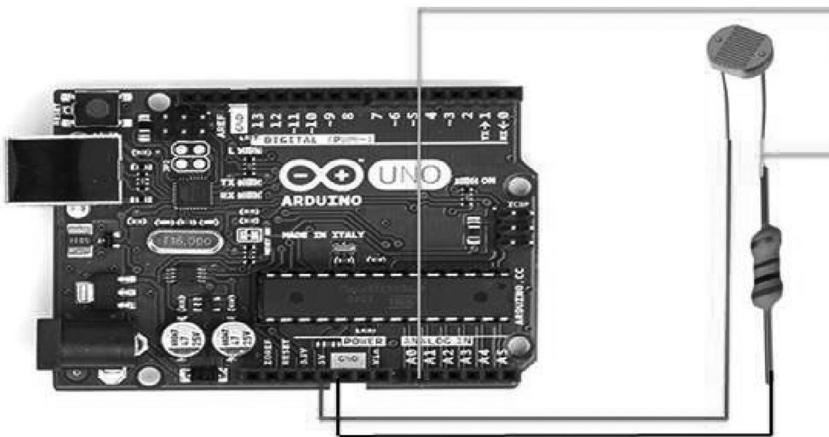

Figure 8.
Arduino R3 Testing
by Utilizing Analog
PIN

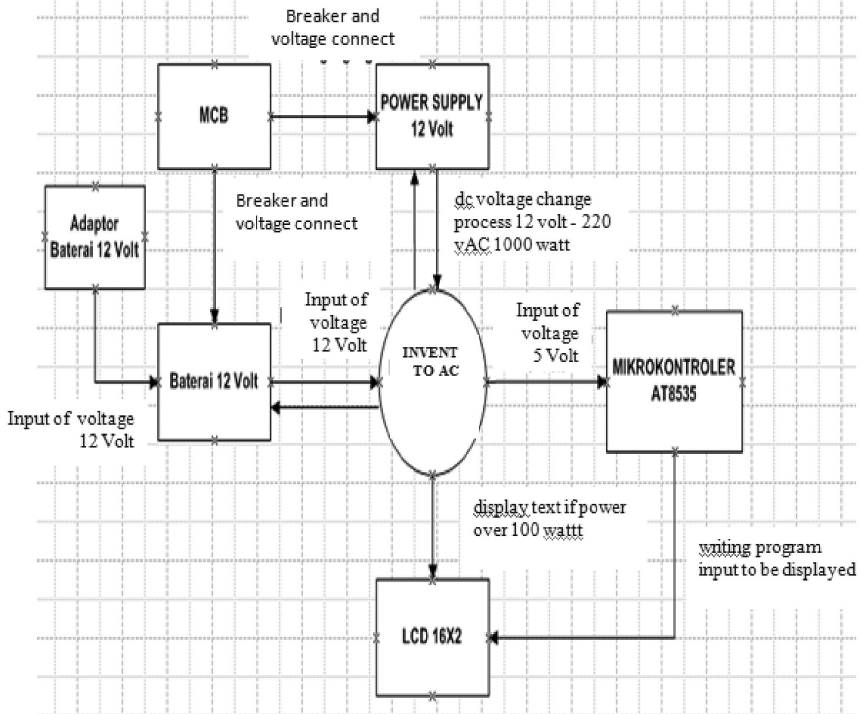

Figure 9.
Context Diagram
Inverter Tool

The program module we use is Arduino.IDE, writing controller application, done in Arduino IDE, writing sketch prototype automation of Arduino Uno Based Cell-Based Solar Cell with 16×2 LCD display in Arduino.IDE.

- (1) Opening and writing in Arduino IDE 1.0.6.
- (2) Open the Arduino IDE app, in this study, the Arduino IDE Persi 1.0.6 application after the Arduino IDE application is opened.
- (3) Reading the Arduino R3 board device.
- (4) Once the Arduino IDE app has been opened, the Arduino R3 board, connected to a USB computer, using a Type A USB cable. As the Arduino R3 board connects to the computer, the serial port on Arduino is Bewarna Hitam. To find out whether the Arduino board is connected or not, click tools.
- (5) Serial monitor. As shown in Figure 12.

If the Arduino board is not connected to the Arduino IDE computer, there must be an error on the PC USB PORT or the computer altitude. For Arduino board to display that is not connected to Arduino board.

The type of microcontroller or controller used is Arduino, with type R3. The selection of R3 type, due to the economical price, has enough digital port to support the system created.

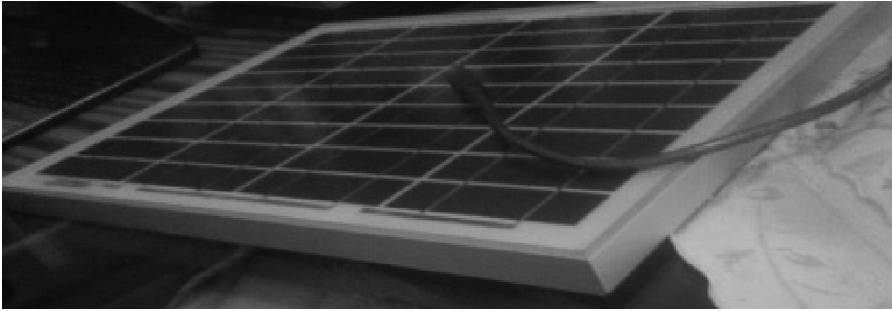

Figure 10.
Solar Cell Testing

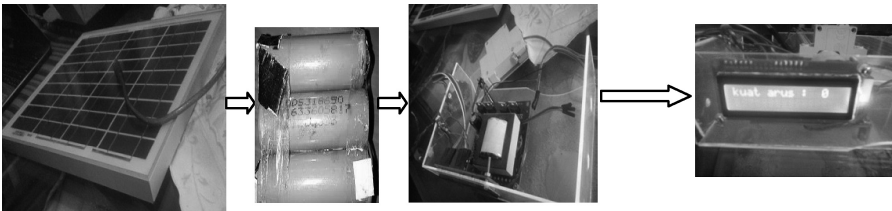

Figure 11.
Combination of Solar
Cell Electrical
Automation Module

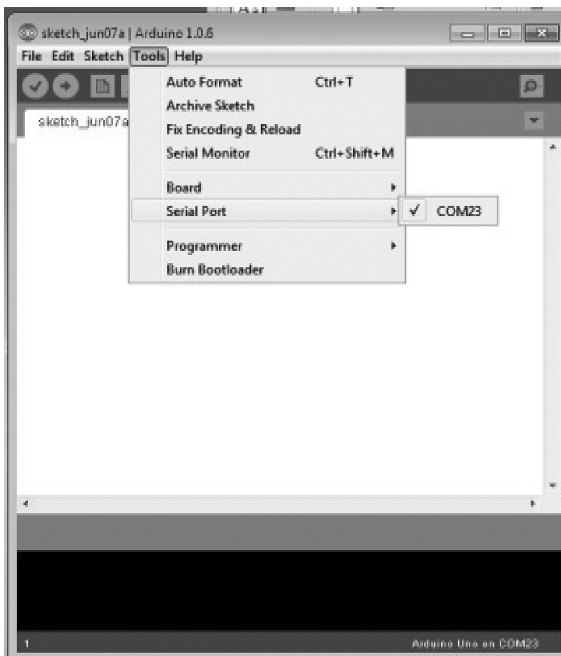

Figure 12.
Display Arduino. IDE
Connected to Board
Arduino

Testing is done by entering a program or a command on the Arduino controller and the output voltage is measured on the Arduino using multimeter.

The solar cell is a solar panel that serves to provide a source of voltage coming from a solar source (DC voltage). The Solar cell works by using a working voltage of 10 W. Tests are conducted to determine the minimum and maximum power.

Implementation of Arduino Uno Solar Cell Automation-Based Automation Device With 16×2 LCD display using solar cell, battery control, and inverter convert DC voltage into Arduino Uno-based AC by displaying temperature information on LCD 1602 + I2C. The purpose of designing this tool is to generate a change of DC to AC with a voltage source through a solar cell.

Table 1.
Output Voltage
Reading

No.	Trial	LED			Minimum of Output	Maximum of Output	Object of Research
		RX	TX	Lamp			
1	On the File	ON then OFF	ON then OFF	ON	3,3	5	Arduino R3
2	No The File	OFF	OFF	OFF	3,3	5	
3	On Going the File	OFF	OFF	FLIP-FLOP	3,3	5	

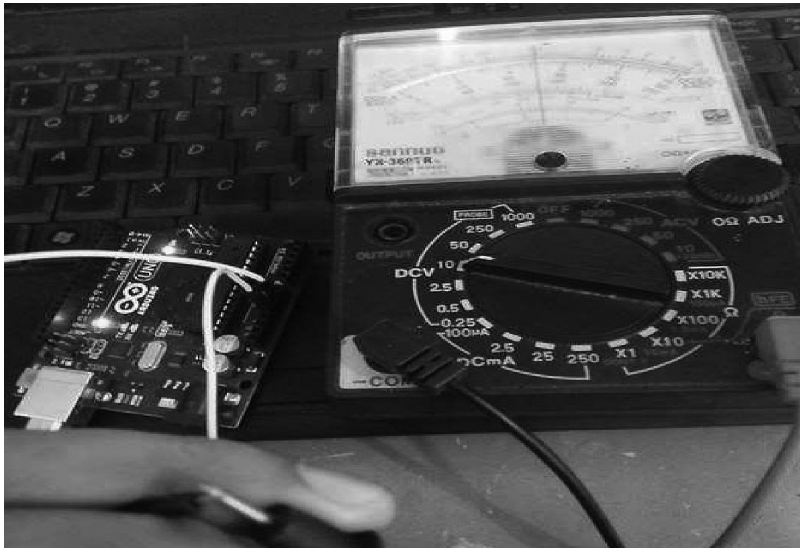

Figure 13.
Test Results with
Multimeter,
Maximum Output
Voltage

Table 2.
Data Reading of
Solar Cell, at
3.3–12 V

Power	Data	Sollar Cell	Delay	Information	Object of Research
0 watt	Not readed	Off	Not Corresponding	Off	Current sens cannot readed
5 watt	Not readed	Off	Not Corresponding	Off the lamp	Current sens cannot readed
10 watt	readed	On	Corresponding	Light The lamp	Current sens readed

Conclusion and future work

This research has successfully developed a device capable of converting solar energy into electrical energy automatically and in real time. This study has succeeded in developing equipment that can convert DC electric power into 10 W AC power, so it can be utilized to fulfill the electrical power supply of office equipment or electronic equipment that is used everyday. It is expected that this research can be developed again so that it can produce a larger electric power by optimizing the storage of electrical energy generated by solar cells.

References

- Irawadi (2016). *Portable Power Plan Solar Cell*. In Proceeding of National Seminar on Science & Technology Application (SNAST), November 26, pp. 332–342.
- Abdul Kadir, (2014), *Introduction to Revision Edition Information Systems*. Andi.Yogyakarta
- Kierby, (2012), *Charging mobile phone battery with solar cell*, Faculty of science and technology Sanata Darma, yogyakarta
- Rosidi, (2016), *Design of Load Monitoring on Micro-Controlled Solar Cell System Using SMS Gateway*, Study Program Strata 1 Engineering Engineering Techniques Faculty Of Engineering University Jember
- Fachri MR, (2015) Monitoring of Arduino-based Solar Panel Parameters in Real Time, *Jurnal Electrical Engineering*, Vol 11. No.4 pp. 123–128.
- Muhammad Syahwil. (2013), *Simple Simulation Guide and Arduino Microcontroller Practice*. pp.125 Andi. Yogyakarta
- Pefrianus Bunga, (2015), Designing Remote Load Control Systems Using Smart Relays. (1) *E-Journal of Electrical and Computer Engineering* Vol.4 No.5 (2015), ISSN: 2301-8402

Corresponding author

Sajadin Sembiring can be contacted at sajadinbiring@gmail.com.